

M= An additional 50 mm for clear structural opening is required.

Cut out size

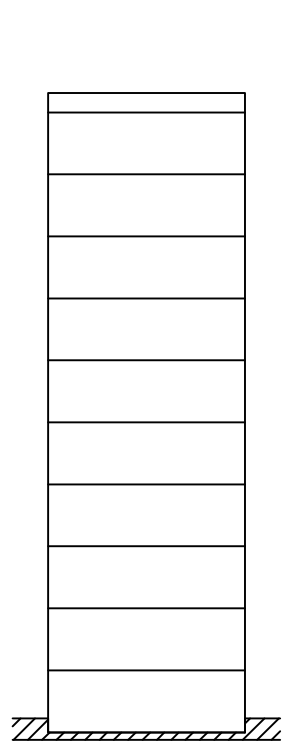

Side C

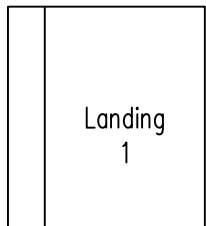
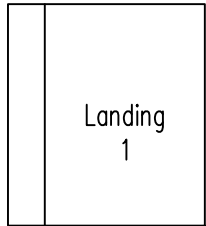
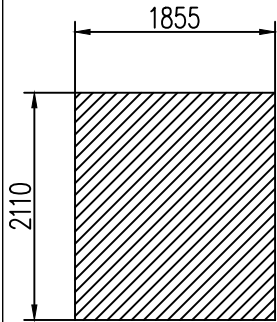
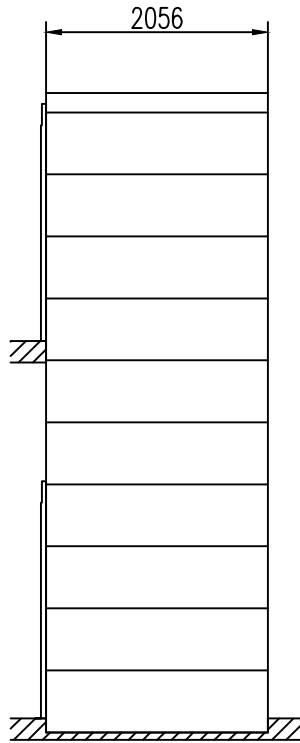

Side B

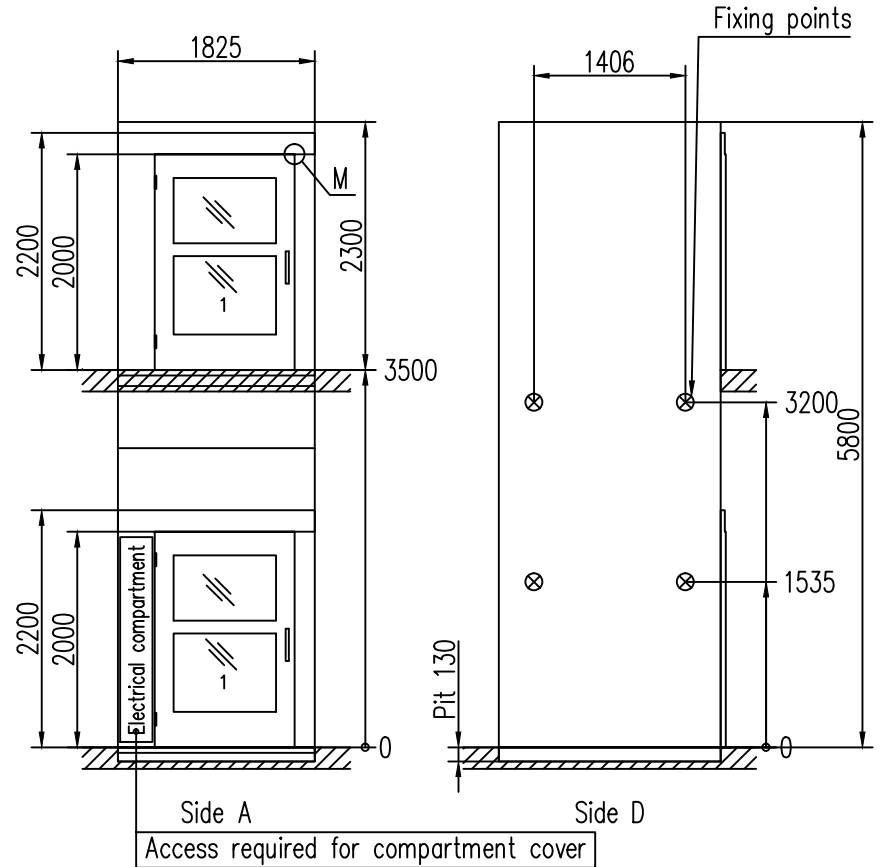

Side A

Side D

Lifting eye bolt

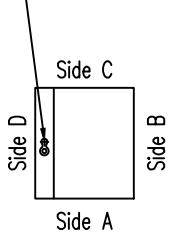

At the start of the lift installation a lifting eye bolt for a rated load of 500 kg has to be provided at the position of the symbol marked on the drawing

197 y 198 Country Club de Barranquilla A8000 2P



Drawn

Constr.

Shaftwall A8000