

Shaft plan view

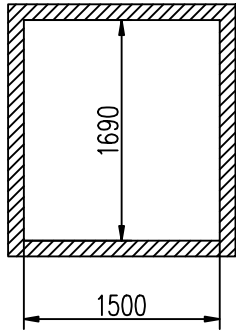

M= An additional 50 mm for clear structural opening is required.

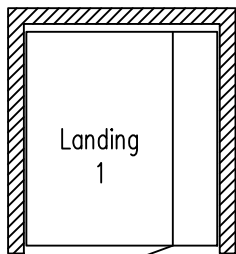
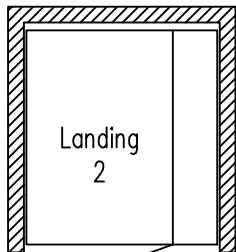

Shaft ceiling with a light.

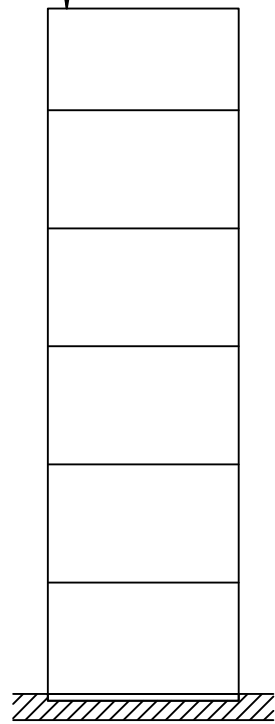

Side C

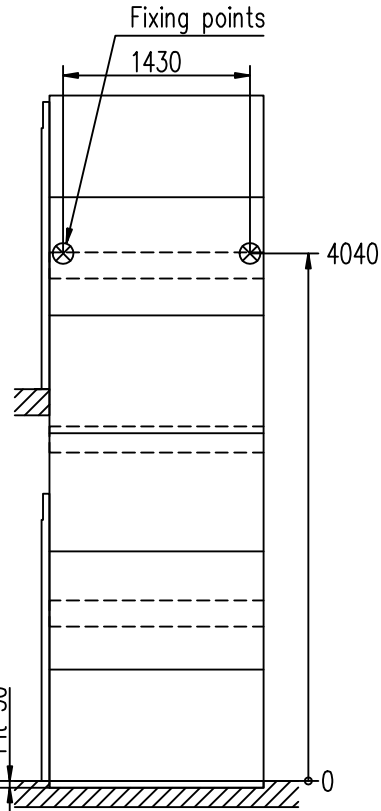

Side D

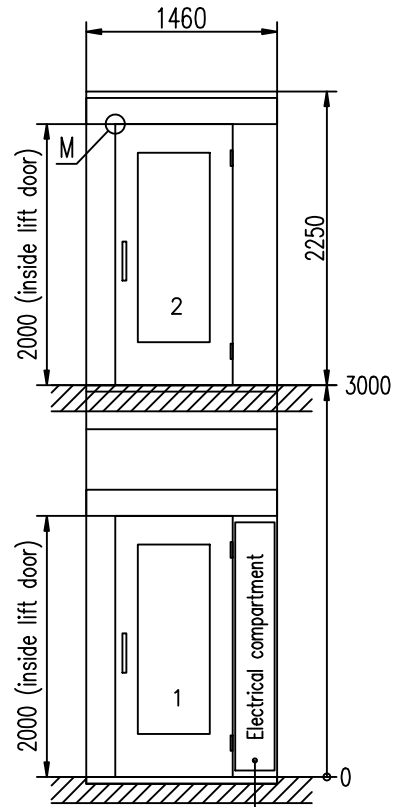

Side A

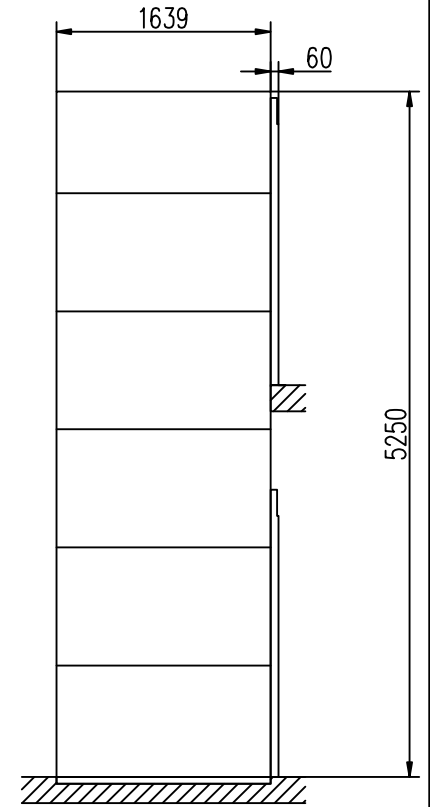

Side B

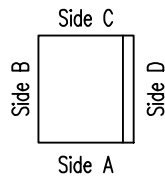

Access required for compartment cover



Drawn  
Constr.

Shaftwall A 5000

Scale  
1:38

File name  
108890-W  
Date  
14-09-11

Dwg-nr  
Sheet  
1