

Shaft plan view

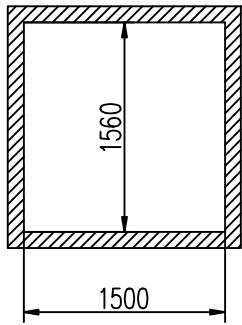

M= An additional 50 mm for clear structural opening is required.

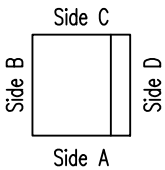
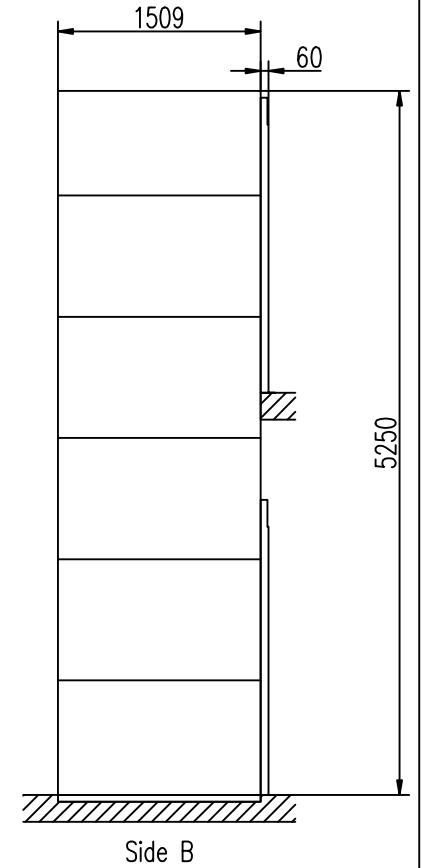
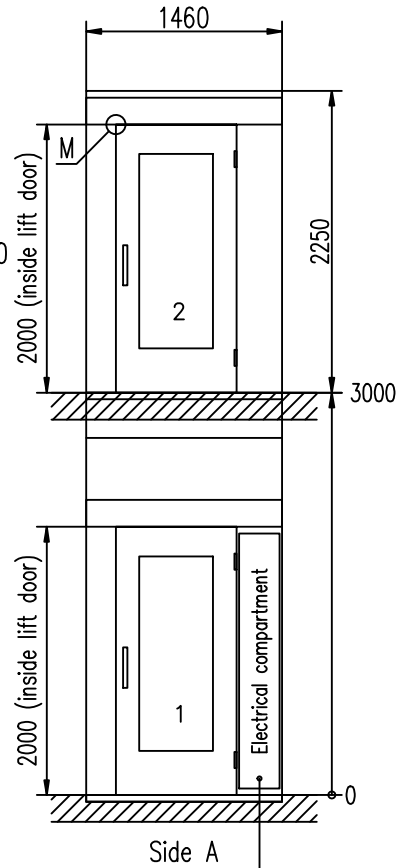
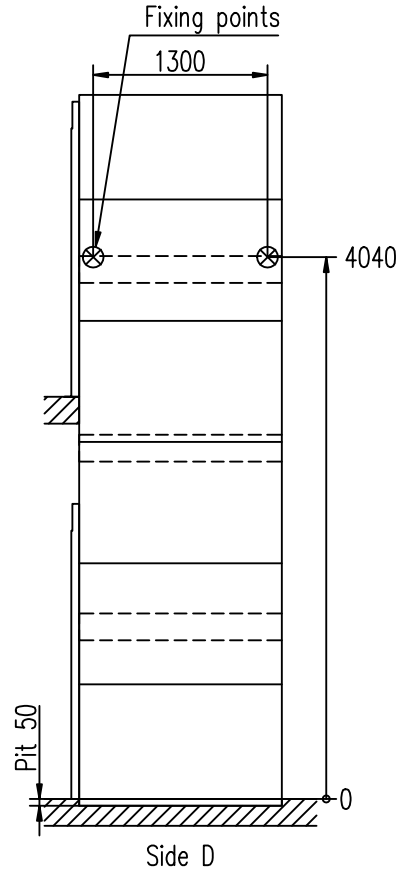
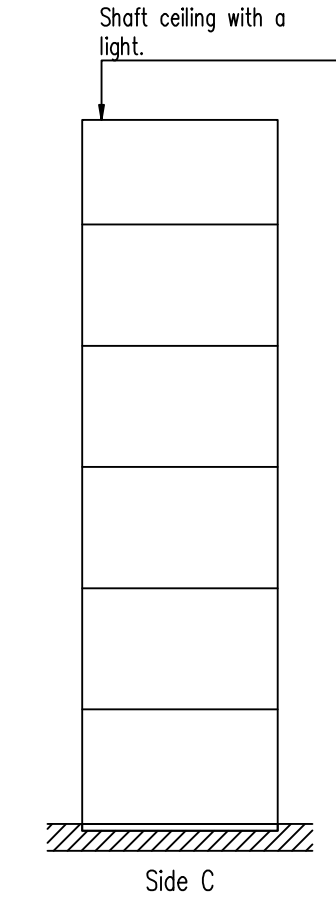
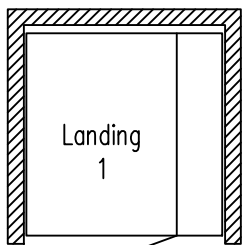
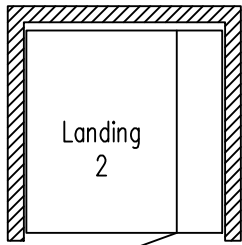

Access required for compartment cover



Drawn
Constr.
Shaftwall A 5000

Scale	File name
1:37	108889-W
Dwg-nr	Date
	14-09-11
	Sheet
	1