

Shaft plan view

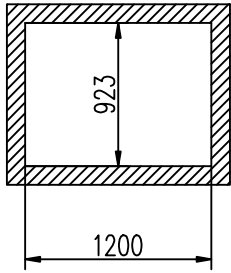

M= An additional 50 mm for clear structural opening is required.

Shaft ceiling with a light.

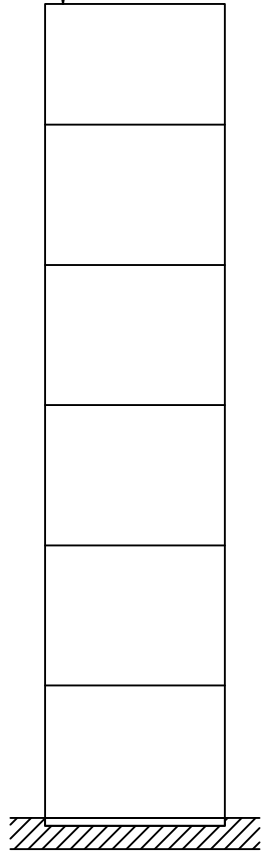

Side C

Fixing points

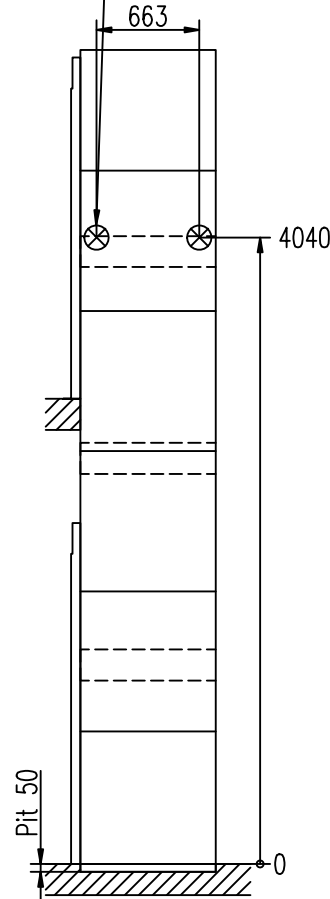

Side D

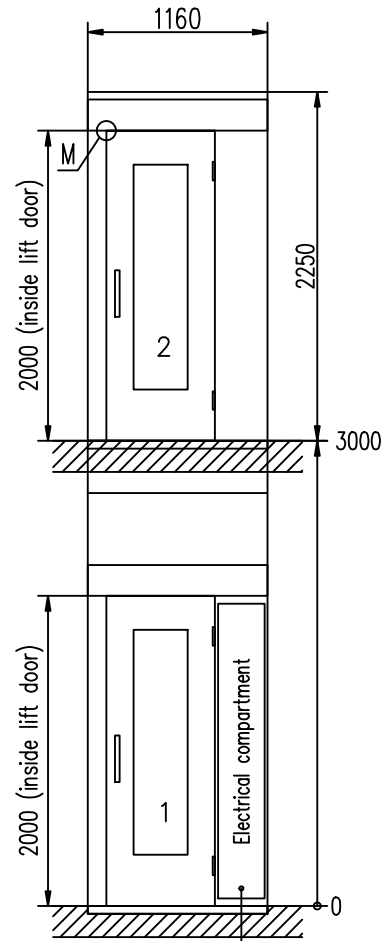

Side A

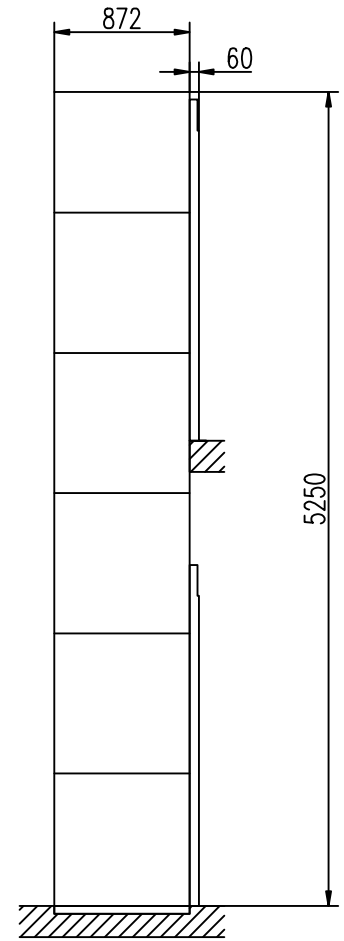

Side B

Access required for compartment cover

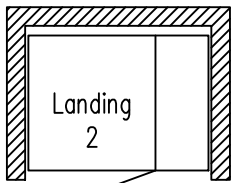

Landing 2

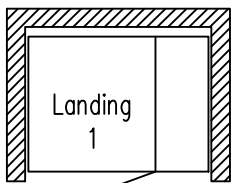

Landing 1

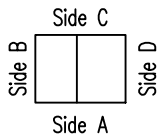

Drawn
Constr.

Shaftwall A4000

Scale
1:32

File name
108678-W

Date
14-09-08

Dwg-nr
Sheet
1